

HSF

NOTES:

Rated Current:15AMP
 Contact Resistance:30mΩ max
 Withstand Voltage:1500V AC/minute
 Insulation Resistance:1000MΩ min
 Operation Temperature:-25°C to +85°C

Contact Material:Brass
 Contact Plating:Sn Over Ni
 Insulator Material:PA66+15%G.F UL94V-2

Recommended P.C.B Layout(Top Side)
 (PCB BOARD TOLERANCE±0.05)

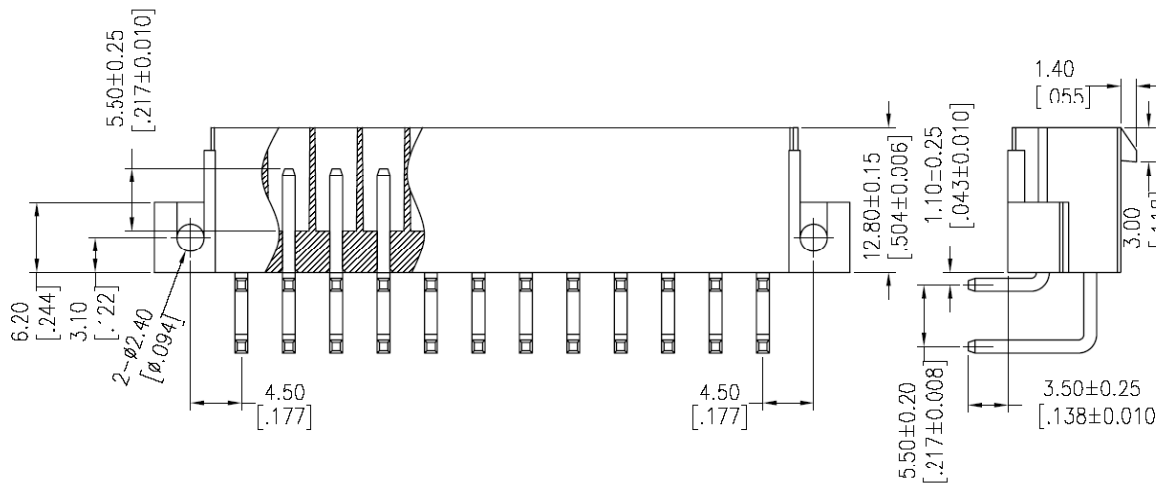
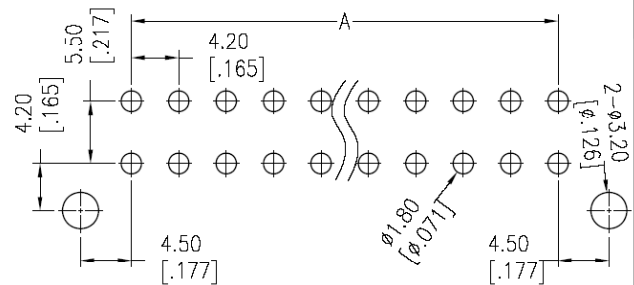
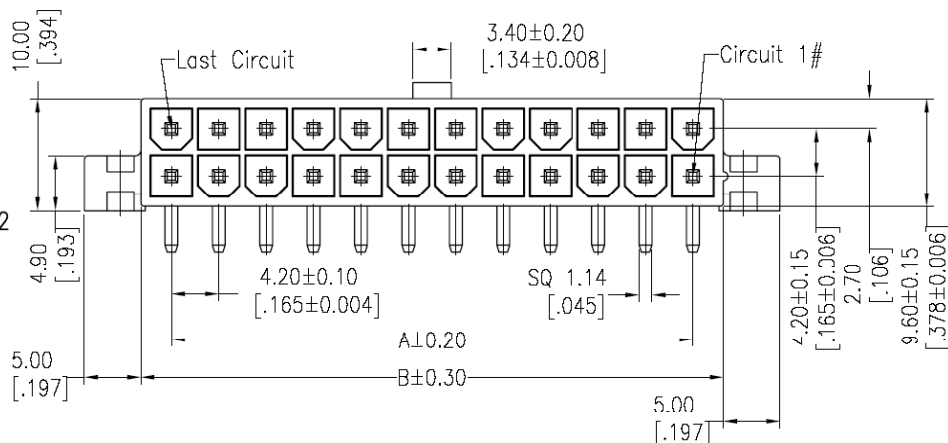

Dimensional & Ordering Information

Circuit	Part No.	Dimension		Pcs /Tray
		A	B	
2x01	4201RA-02	---	5.40	410
2x02	4201RA-04	4.20	9.60	230
2x03	4201RA-06	8.40	13.80	160
2x04	4201RA-08	12.60	18.00	130
2x05	4201RA-10	16.80	22.20	100
2x06	4201RA-12	21.00	26.40	80
2x07	4201RA-14	25.20	30.60	70
2x08	4201RA-16	29.40	34.80	60
2x09	4201RA-18	33.60	39.00	60
2x10	4201RA-20	37.80	43.20	50
2x11	4201RA-22	42.00	47.40	50
2x12	4201RA-24	46.20	51.60	40

OPERATION					DRAW			SCALE		HO CHIEN		
X.X ±0.40					DRAW			1:1		www.hochien.com		
X.XX ±0.25					DESIGN			UNIT		PART NO.		
X.XXX ±0.15					CHECK			SIZE		4201RA-XX		
Angle ± 3'					APPROVE			SHEET		TITLE:		
DIM TOL					APPROVE			1/2		4.20 MINI FIT DUAL ROW 90° WITH EAR		
					PROJ.			Customer NO.				
A1	09/09/12	Packing code from "0" to "A"			OPERATION	DRAW	William Chen	09.09.12	SCALE	1:1	PART NO.	
A0	08/08/04	NEW			DESIGN				UNIT	mm	TITLE:	
REV	DATE	MODIFICATION DESCRIPTION	CHANGE	APPROVE	CHECK				SIZE	A4	4.20 MINI FIT DUAL ROW 90° WITH EAR	
					APPROVE				SHEET	1/2	Customer NO.	

HSF

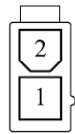

2x01P

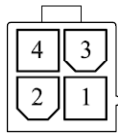

2x02P

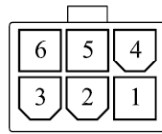

2x03P

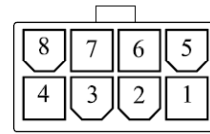

2x04P

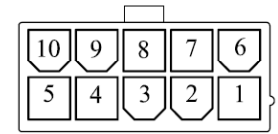

2x05P

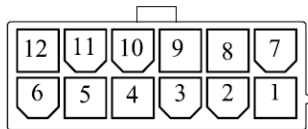

2x06P

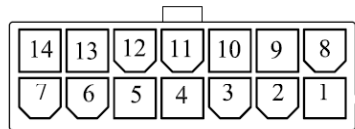

2x07P

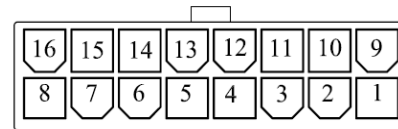

2x08P

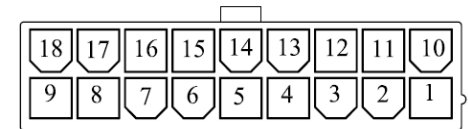

2x09P

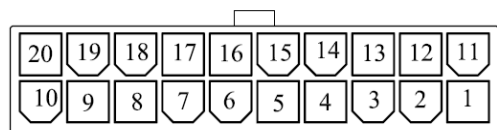

2x10P

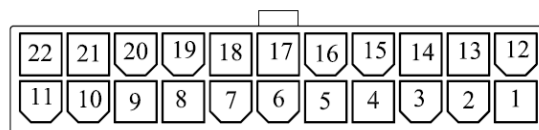

2x11P

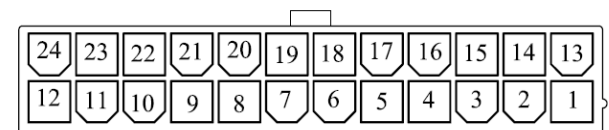

2x12P

						OPERATION	DRAW	<i>William Chen</i>	<i>09.09.12</i>	SCALE	1:1	HO CHIEN www.hochien.com	
						X.X	±0.40	DESIGN		UNIT	mm		
A1	09/09/12	Packing code from "0" to "A"				X.XX	±0.25	CHECK		SIZE	A4	TITLE:	4.20 MINI FIT DUAL ROW 90° WITHOUT POST
A0	08/08/04	NEW				X.XXX	±0.15	APPROVE		SHEET	2/2	Customer NO.	
REV	DATE	MODIFICATION	DESCRIPTION	CHANGE	APPROVE	Angle	± 3'			PROJ.	⌀		
						DIM	TOL						

HSF

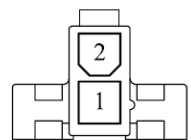

2x01P

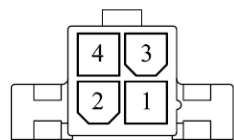

2x02P

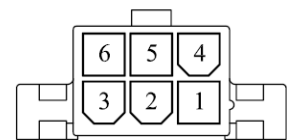

2x03P

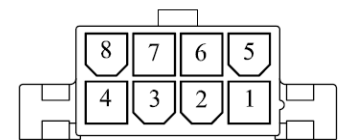

2x04P

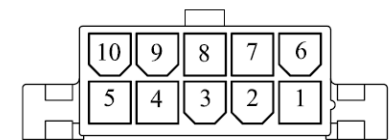

2x05P

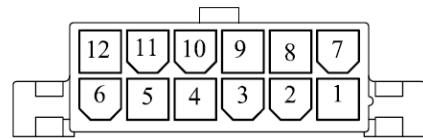

2x06P

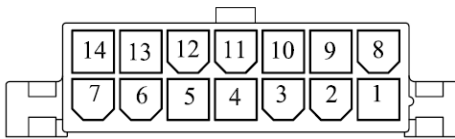

2x07P

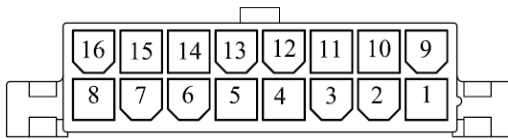

2x08P

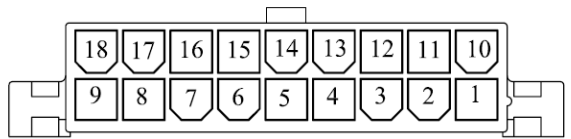

2x09P

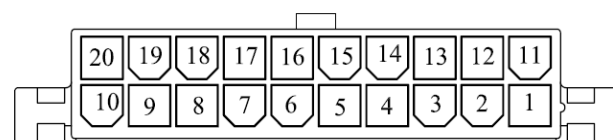

2x10P

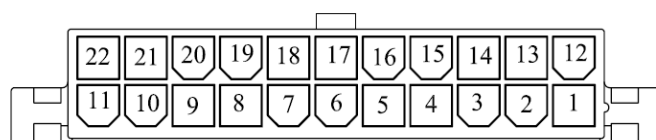

2x11P

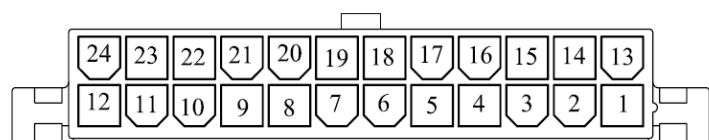

2x12P

					OPERATION	DRAW	<i>William Chen</i>	<i>09.09.12</i>	SCALE	1:1	HO CHIEN www.hochien.com	
					X.X ±0.40	DESIGN			UNIT	mm		
A1	09/09/12	Packing code from "0" to "A"		_____	X.XX ±0.25	CHECK			SIZE	A4	PART NO.	4202RA-XX
A0	08/08/04	NEW		_____	X.XXX ±0.15	APPROVE			SHEET	2/2	TITLE:	4.20 MINI FIT DUAL ROW 90° WITH EAR
REV	DATE	MODIFICATION	DESCRIPTION	CHANGE	APPROVE				PROJ.	☯	Customer NO.	
					Angle ± 3'							
					DIM TOL							