

RoHS Compliant

REV.	ECN NO	LTR	DESCRIPTION	REVISER	DATE

TABLE

PIN NO.	DIMENSION OF COMPARISON				P/N
	A	B	C	D	
36	25.00	7.65	6.00	9.15	PCI-E36
64	39.00	21.65	20.00	23.15	PCI-E64
98	56.00	38.65	37.00	40.15	PCI-E98
164	89.00	71.65	70.00	73.15	PCI-E164

NOTE:
 MATERIAL:
 HOUSING:THERMOPLASTIC(NYLON+GF)
 CONTACT:BRASS
 PLATING:
 CONTACT: GOLD PLATING
 SPECIFICATION:
 VOLTAGE RATING: 50V
 CURRENT RATING: 1.1A
 CONTACT RESISTANCE TERMINAL:20mΩ MAX
 DIELECTRIC WITHSTANDING VOLTAGE:500V AC
 INSULATION RESISTANCE:1000MΩ MIN

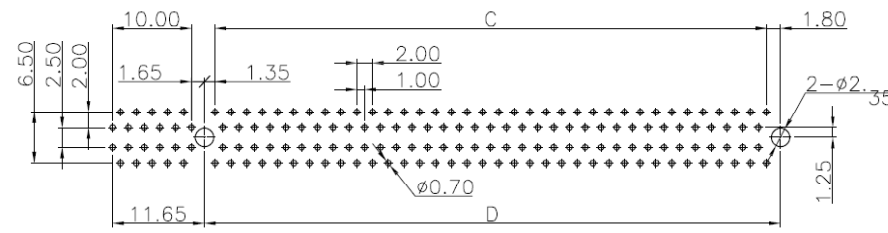
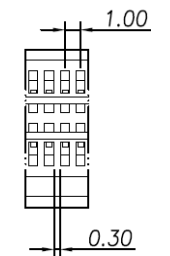
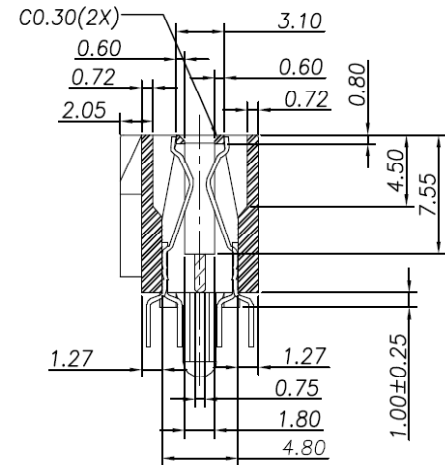
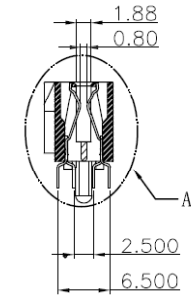
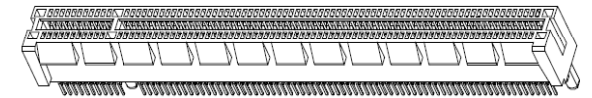
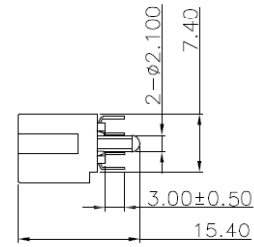
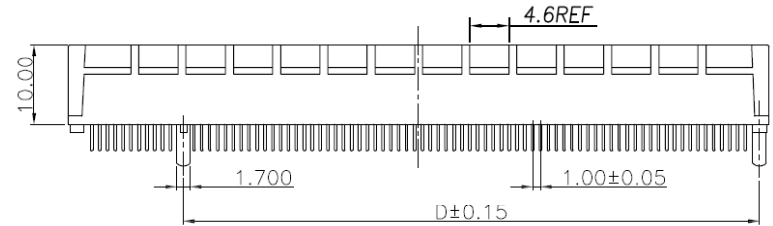
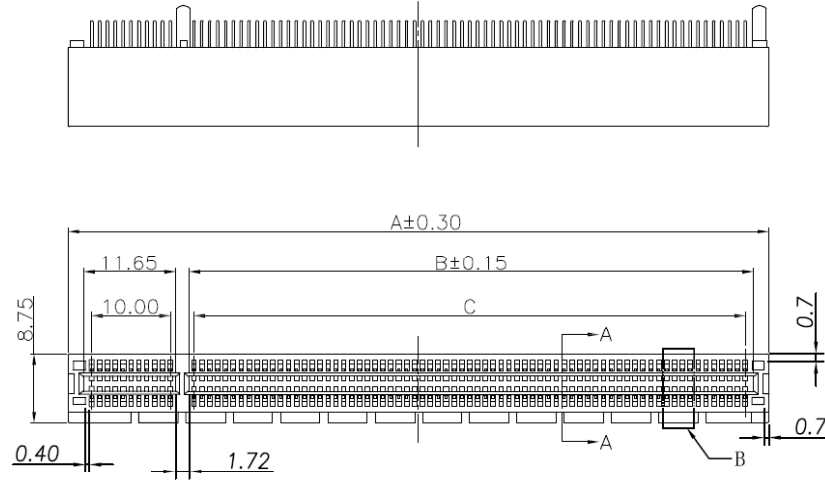

RECOMMENDED PCB LAYOUT

图号 (DWG NO)		单位 (UNIT):	MM	HO CHIEN				
模号 (MODEL NO)		比例 (SCALE):	1:1					
版次 (REV):	A/0	页次 (PAGE):	1/1	<table border="1" style="width: 100%;"> <tr> <td>品名 (ITEM NO)</td> <td>PCIe express with post(No latch)</td> </tr> <tr> <td>料号 (PART NO)</td> <td>See table</td> </tr> </table>	品名 (ITEM NO)	PCIe express with post(No latch)	料号 (PART NO)	See table
品名 (ITEM NO)	PCIe express with post(No latch)							
料号 (PART NO)	See table							
设计 (DESIGN)	Lizhenghua	未注公差	TOLERANCE UNSPECIFIED					
审核 (CHECKED)		X.X	± 0.30					
核准 (APPROVED)		X.XX	± 0.15					
		X.XXX	± 0.10					
		X"	± 5°					
		X*"	± 2°					