

REVISIONS

REV	DESCRIPTION	BY	DATE	APPROVED
--	INITIAL RELEASE PER XCX X-	--	--	

WIRE LENGTHS MEASURED FROM STRAIN RELIEF

TINNED ENDS TYP.

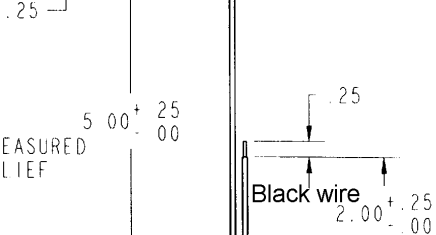

(Ø .528)
DIN RECEPTACLE BODY

SCALE 0.500

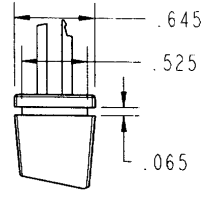

DETAIL A
SCALE 1.000

PRELIMINARY
17-Jan-05

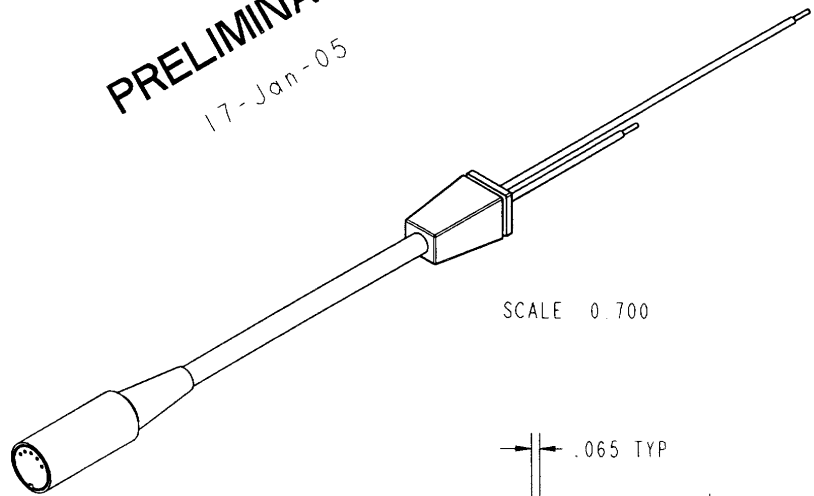

SCALE 0.700

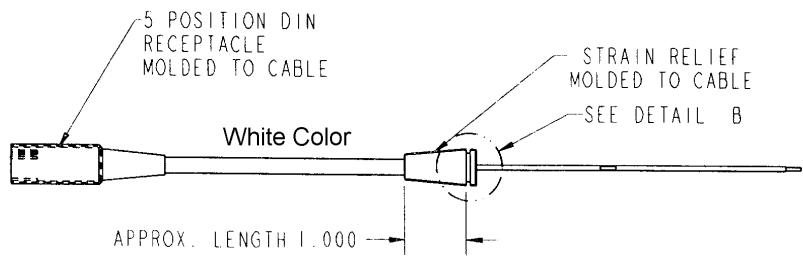

White Color,
Shielding Cable

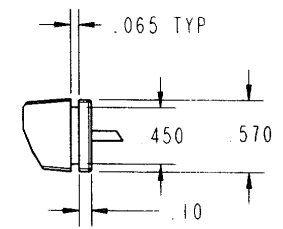

DETAIL B
SCALE 1.000

NOTES AND SPECIFICATIONS

MATERIAL:
 OUTER JACKET: Ø .25" DIA COLOR WHITE
 CONDUCTORS: 2 CONDUCTOR #18 GAUGE WIRE, TINNED ENDS
 5 POSITION DIN RECEPTACLE ONE END
 OVERALL CORD LENGTH: 6 FEET ± 3 INCHES

BOM	SALES	PURCH
UNIT OF MEASURE (U/M)		
PROJECT TFX		
DRAWN BY CWP		
UNLESS OTHERWISE SPECIFIED DIMENSIONS ARE IN INCHES (MM) TOLERANCES ON		
2 PLACE DECIMALS	3 PLACE DECIMALS	4 PLACE DECIMALS
±0.01	±0.005	±0.0002
ANGLES ±0.5		
SURFACE FINISH 63 OR BETTER REMOVE ALL BURRS AND BREAK ALL SHARP EDGES		

HO CHIEN www.hochien.com			
TITLE POWER CORD			
CODE IDENT PE	SIZE B	DWG NO. CA-BC019-0001B	REV. X0
SCALE 0.333	FORM 2401	Revision B	SHEET 1 OF 1

REVISION	DESCREPTION	DATE	APPD
0	SET UP	JAN/26/2005	C.Y.LIN

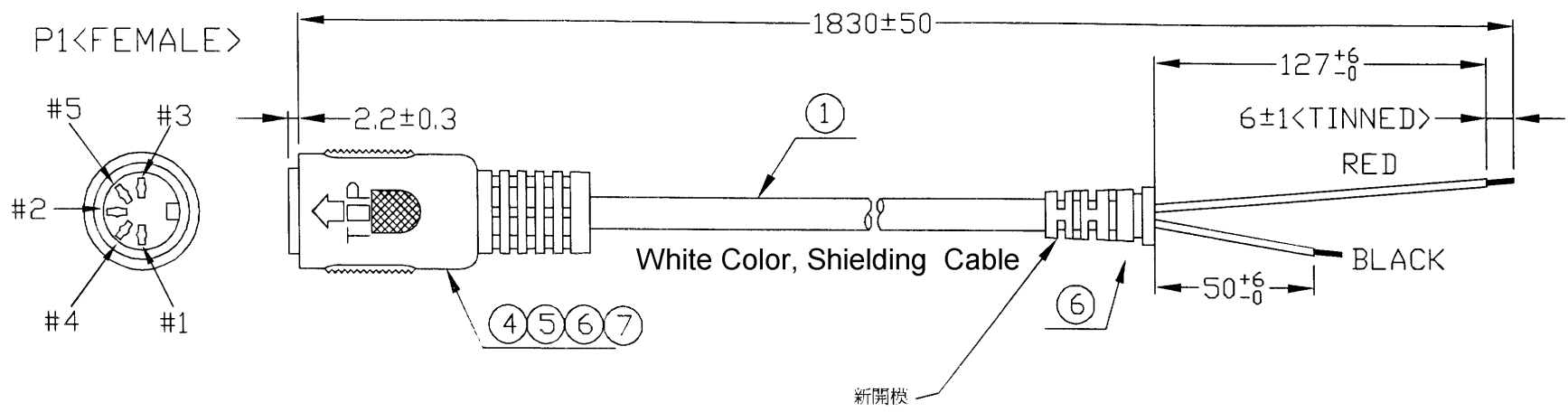

NOTE:
NEED SAMPLES

*	390	CARTON:46*30*25CM	1/200	PCS						
*	390	PE BAG:30*28*0.08MM	1/200	PCS						
*	390	PE BAG:6*8*0.06MM	1	PCS	OUTER MOLDING	DNS002				
*	390	TIE-A100/BK10	1	PCS	INNER MOLDING	MF020				
*	390	JUMP WIRE-26-1007-2*20*2MM	3	PCS						

PIN ASSIGNMENT
P1
1+2+4 ——— BLACK

3+5 ——— RED

NO	TYPE	DESCRIPTION	QTY	UNIT
6	370	PVC-WH03/50	8.5	G
5	370	PVC-IN	2.0	G
4	220	SOL-WIRE-63/37-1.0	0.3	G
3	220	CDN-05S/E<180°>	1	PCS
2	210	18*2C+POWDER-WH03-6.0N White Color, <CORE COLOR:RED,BLACK> Shielding Cable	1.83	M

 **HO CHIEN ENTERPRISE CO. LTD**

TITLE: 5F Din Molding 6' w Strain Relief
White Color, Foil shielding

PAGE: 1 OF 1

HO CHIEN P/N. CA -BC019 -0001B

DR: RON CHEN	CHK: J.T.CHEN	APPD: C.Y.LIN
--------------	---------------	---------------